



### Nominal data

Type	4314 NN	
Nominal voltage	VDC	24
Nominal voltage range	VDC	12 .. 28
Speed (rpm)	min <sup>-1</sup>	2700
Power consumption	W	4.1
Min. ambient temperature	°C	-20
Max. ambient temperature	°C	75
Air flow	m <sup>3</sup> /h	190
Sound power level	B	5.4
Sound pressure level	dB(A)	43

ml = Max. load · me = Max. efficiency · fa = Free air · cs = Customer specification · ce = Customer equipment  
Subject to change

**Technical description**

<b>Weight</b>	0.25 kg
<b>Dimensions</b>	119 x 119 x 32 mm
<b>Impeller material</b>	Glass-fiber reinforced PA plastic
<b>Housing material</b>	Glass-fiber reinforced PBT plastic
<b>Part no.</b>	9293510701
<b>Airflow direction</b>	Exhaust over struts
<b>Direction of rotation</b>	Clockwise, viewed toward rotor
<b>Bearing</b>	Ball bearing
<b>Service life L10 at 40 °C</b>	72.500 h
<b>Service life L10 at maximum temperature</b>	30.000 h
<b>Cable</b>	With leads AWG 24, TR 64

## Product drawing

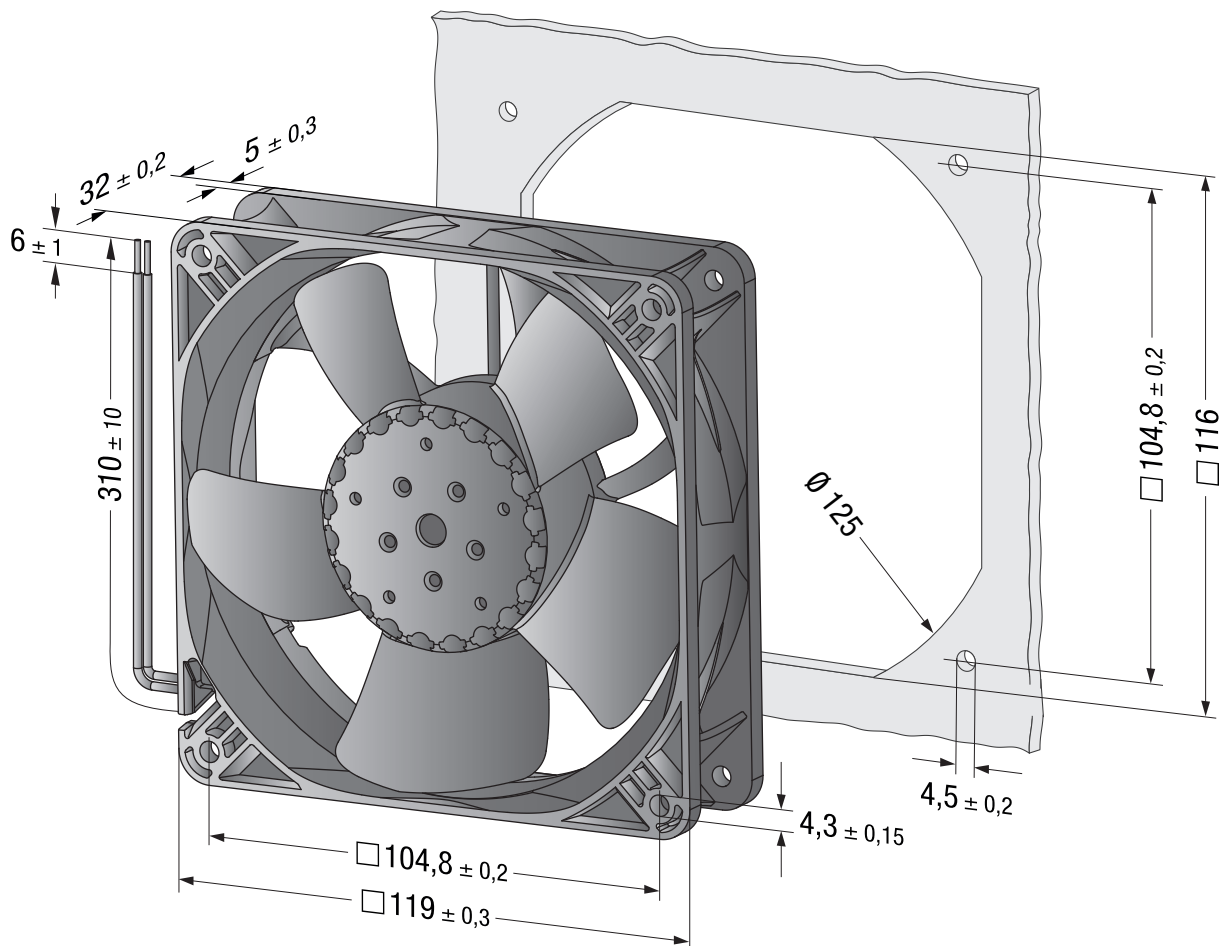

Curves

