

For professional use only. Please refer to the conditions of use of our catalogue.

March 2002

4GDS25 146x216L code Z18-05

Voltage	Frequency	Input power	Current	Capacitor	Air flow	Rotational speed	Sound level	Direction of rotation	Max. Air temp.
V	Hz	Wa	A	μF	m ³ /h	rpm	dBA	↻	°C
230	50	83	0,37	2	740	980	50	L	-20 / +70
230	60	94	0,43	2	690	910	49	L	-20 / +70

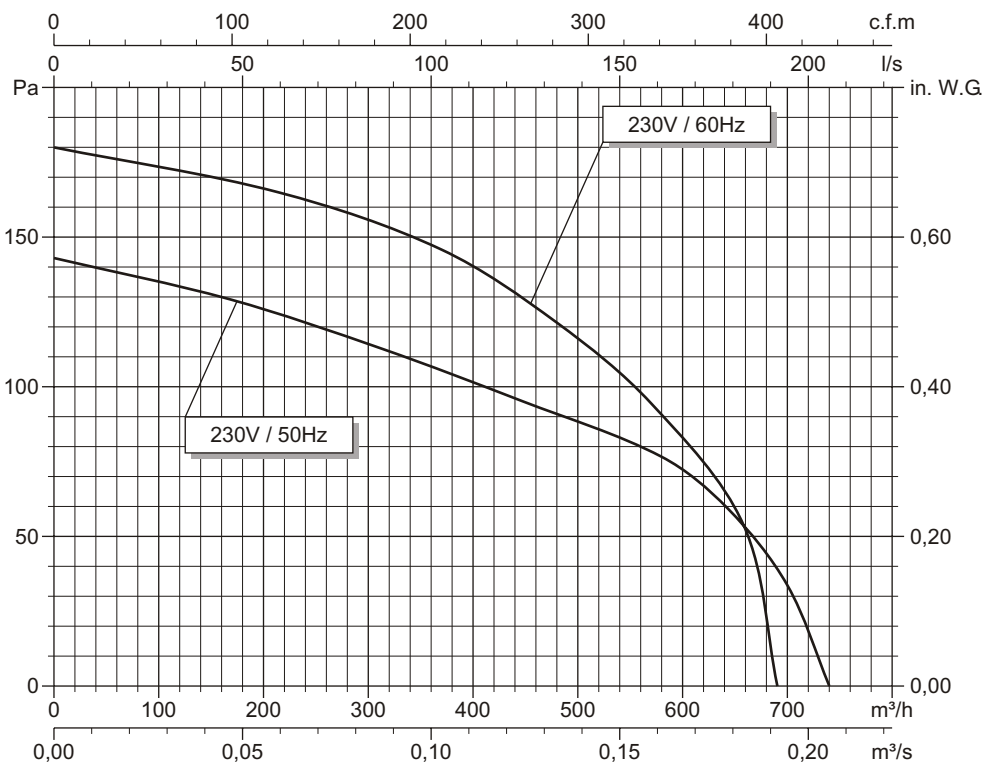
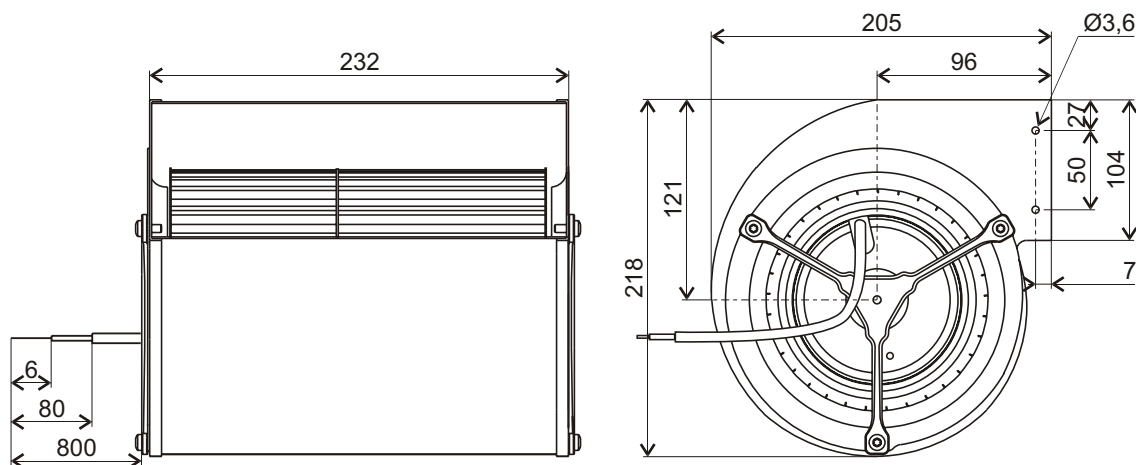

- Ball bearings.
- Cl.F windings protected by thermal cut-out.
- Protection IP 44.
- Balancing G2.5.
- Steel painted black scroll.
- Galvanised steel impeller

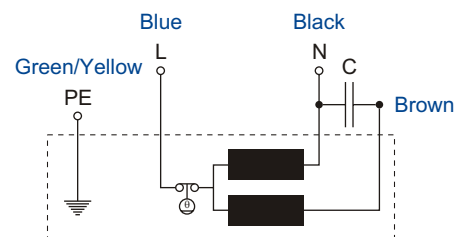

Capacitor for 50Hz	Capacitor for 60Hz	Finguer guard
19008-0	19008-0	21338-0