

Motor data sheet

M3AA 71B 4

Definition	Data	Unit	Remarks
Product code	3GAA072312-***E		
Voltage code	D		
Type/Frame	M3AA 71B 4		
Design	CENELEC		
Efficiency class	IE1		
Rated output P_N	0.37	kW	
Rated voltage U_N	400	V D	± 5 % (IEC 60034-1)
Rated frequency f_N	50	Hz	± 2 % (IEC 60034-1)
Rated speed n_N	1375	r/min	
Rated current I_N	0.96	A	
Starting current I_S/I_N	3.8		
Nominal torque T_N	2.5	Nm	
Locked rotor torque T_l/T_N	2		
Maximum torque T_b/T_N	2.2		
Efficiency - full load 100%	69.7	%	Acc. to IEC 60034-2-1
Efficiency - 75%	71.9	%	
Efficiency - 50%	71.1	%	
Power factor - full load 100%	0.79		
Bearing DE/NDE	6203-2Z/C3 6202-2Z/C3		
Sound pressure level L_{pA} dB	45	dB(A)	+3dB(A)
Moment of inertia $J = \frac{1}{4} GD^2$ kgm ²	0	kg-m ²	
Weight	5.9	kg	

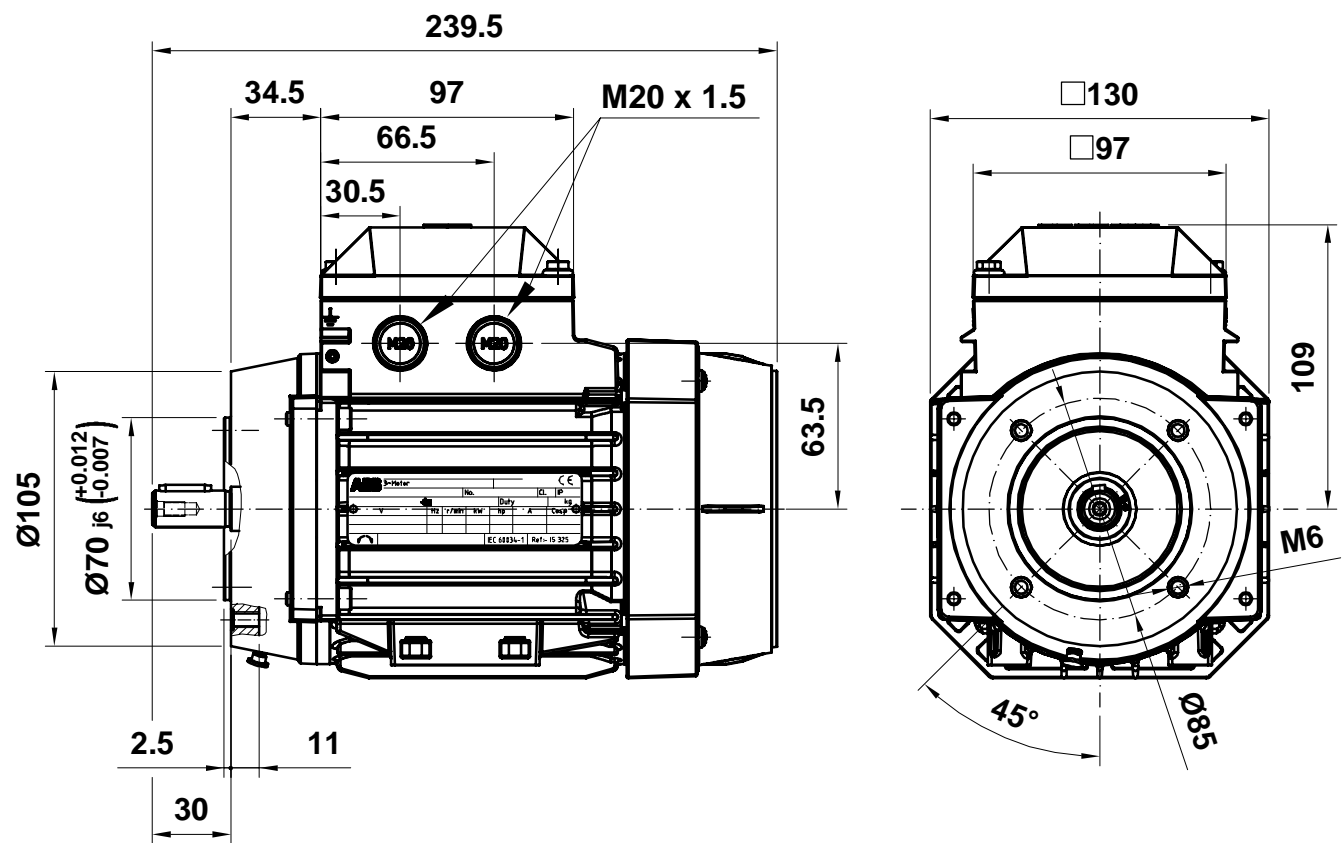
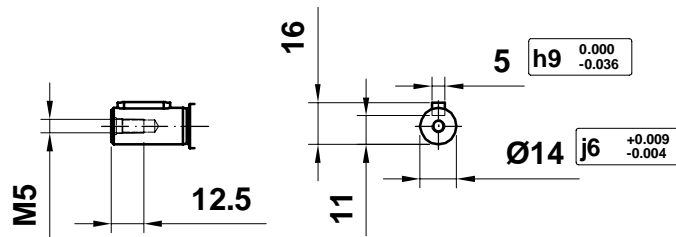

M3AA 071

Motor Dimension Print	Motor Type : M3AA 071	Document Nº : A1.5012 / 3D A2.5012
Description : Motor flange mounted IM3601 / Motor con brida IM3601		