

612 F

## DC axial compact fan



### Nominal data

Type	612 F	
Nominal voltage	VDC	12
Nominal voltage range	VDC	10.8 .. 13.2
Speed	min <sup>-1</sup>	3900
Power input	W	1.0
Min. ambient temperature	°C	-20
Max. ambient temperature	°C	70
Air flow	m <sup>3</sup> /h	29
Sound power level	B	4.4
Sound pressure level	dB(A)	27

ml = max. load · me = max. efficiency · fa = running at free air · cs = customer specs · cu = customer unit  
Subject to alterations

## Technical features

<b>General description</b>	<p>Particular design features:            Compact fan with low power consumption.            Some models suitable for use at high ambient temperatures.</p> <p>General features:            Material: fibreglass-reinforced plastic. Impeller PA, housing PBT.            Electronic commutation completely integrated.            Protected against reverse polarity and locking.            Connection via single strands AWG 28, TR 64, bared and tin-plated.            Air exhaust over bars. Direction of rotation counter-clockwise seen on rotor.            Mass: 30 g.</p>
<b>Mass</b>	0.030 kg
<b>Dimensions</b>	60 x 60 x 15 mm
<b>Material of impeller</b>	Fiberglass-reinforced PA plastic
<b>Housing material</b>	Fiberglass-reinforced PBT plastic
<b>Direction of air flow</b>	Air exhaust over bars
<b>Direction of rotation</b>	Left, looking at rotor
<b>Bearing</b>	Sintec sleeve bearing
<b>Lifetime L10 at 20 °C</b>	50000 h
<b>Lifetime L10 at 60 °C</b>	20000 h
<b>Connection line</b>	Single strands AWG 28, TR 64, bared and tin-plated.
<b>Motor protection</b>	Protected against reverse polarity and locking.
<b>Locked-rotor protection</b>	Impedance protection
<b>Approval</b>	VDE, CSA, UL, CE

612 F

# DC axial compact fan

## Product drawing

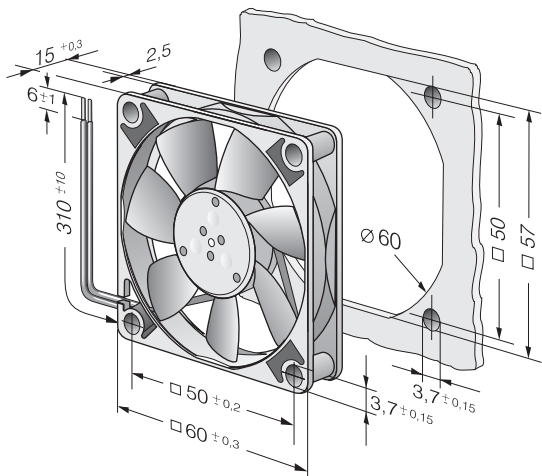

## Charts: Air flow

