

Motor data sheet

M2AA 71A 2

Definition	Data	Unit	Remarks
Product code	3GAA071001-***E		
Voltage code	D		
Type/Frame	M2AA 71A 2		
Design	CENELEC		
Efficiency class	IE3		
Rated output P_N	0.37	kW	
Rated voltage U_N	400	V D	± 5 % (IEC 60034-1)
Rated frequency f_N	50	Hz	± 2 % (IEC 60034-1)
Rated speed n_N	2800	r/min	
Rated current I_N	0.95	A	
Starting current I_S/I_N	4.9		
Nominal torque T_N	1.26	Nm	
Locked rotor torque T_l/T_N	2.7		
Maximum torque T_b/T_N	2.7		
Efficiency - full load 100%	73.8	%	Acc. to IEC 60034-2-1
Efficiency - 75%	75.8	%	
Efficiency - 50%	73.9	%	
Power factor - full load 100%	0.76		
Bearing DE/NDE	6203-2Z/C3 6202-2Z/C3		
Sound pressure level L_{pA} dB	58	dB(A)	+3dB(A)
Moment of inertia $J = \frac{1}{4} GD^2$ kgm ²	0	kg-m ²	
Weight	4.9	kg	

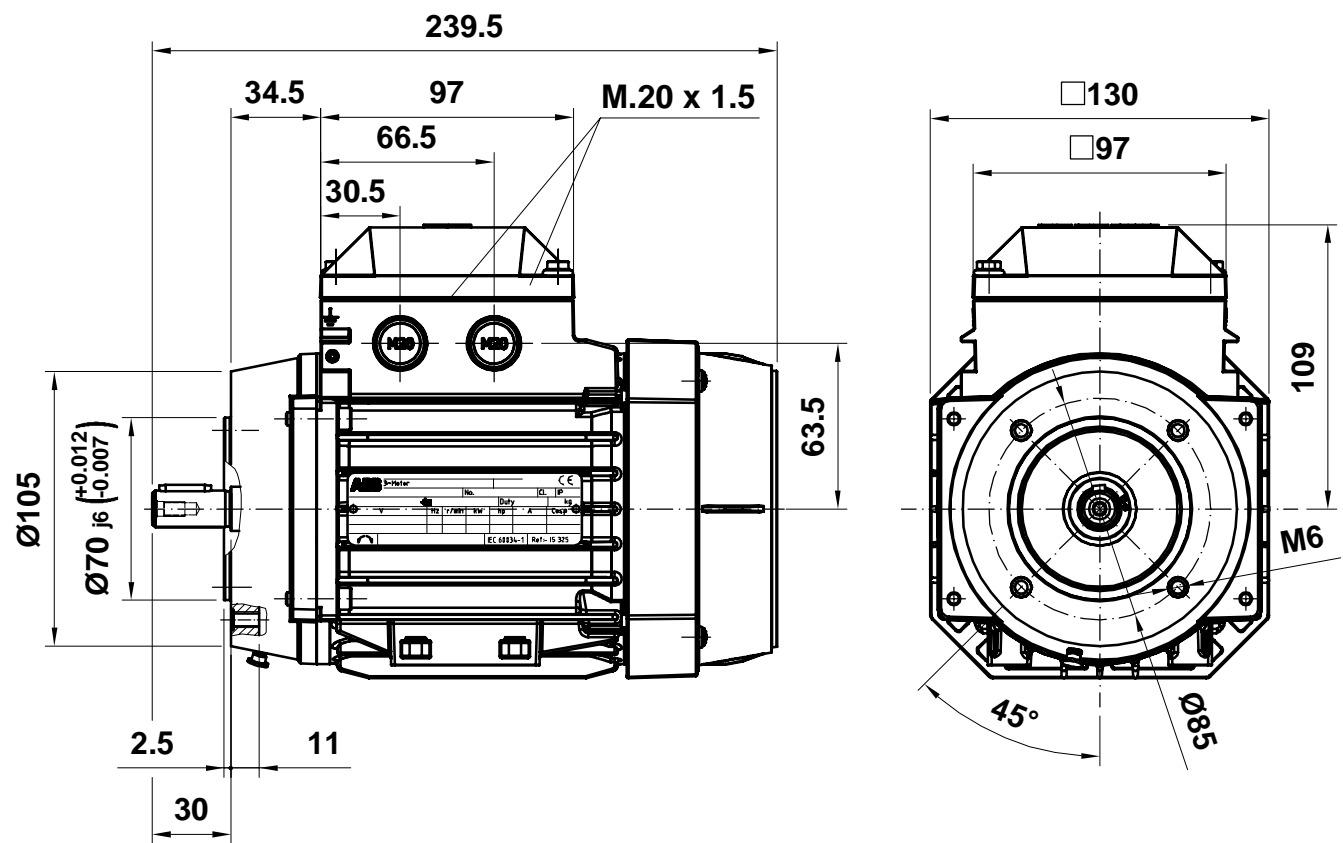
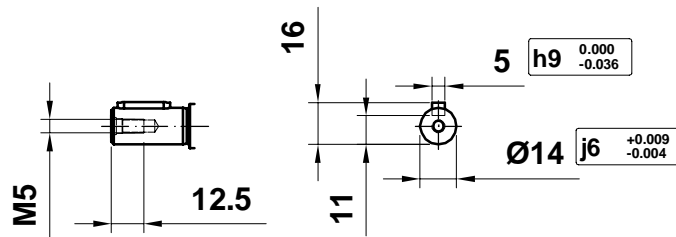

M2AA 071

Motor Dimension Print	Motor Type : M2AA 071	Document Nº : A1.5402 / 3D A2.5012
Description : Motor flange mounted IM3601 / Motor con brida IM3601		